

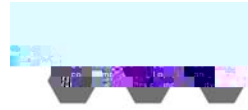

The Joint Advanced Materials and Structures Center of Excellence

FAA Sponsored Project Information



- Principal Investigators & Researchers
 - Dirk Heider (PI)
 - John W. Gillespie, Jr. (Co-PI)
 - Solange Amouroux
 - “C” Josiah Hughes
- FAA Technical Monitor
 - Curtis Davies
- Industry Participation
 - Gore (Munich, Germany)
 - Provided membrane materials, access to instrumentation and technical input
 - Donaldson Membranes (Warminster, PA)
 - Provided membrane materials
 - Hexcel (Seguin, Texas)
 - Provided resin and fabric material and technical input
 - Cytec (Anaheim, CA)
 - Provided resin and fabric material and technical input
 - EADS (Augsburg, Germany)
 - Provided technical and financial input
 - Boeing (Philadelphia, PA)
 - Provided technical input
 - Embraer (São José dos Campos, Brazil)
 - Provided technical input

AEROSPACE VARTM'D COMPONENTS

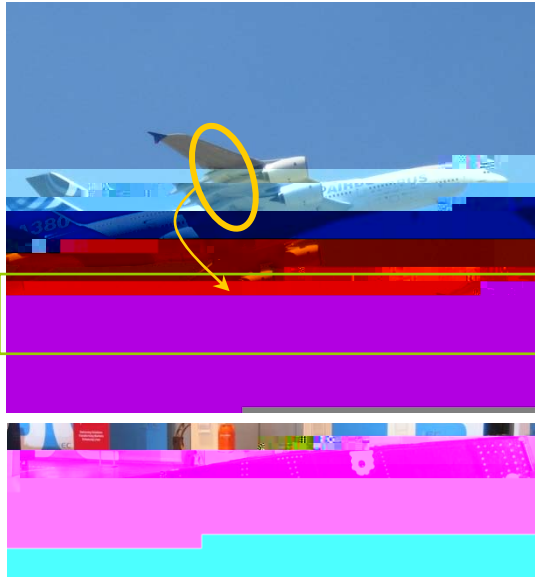

Flap tracks for the A380



Pressure Dome



CH-47 Chinook Forward Pylon

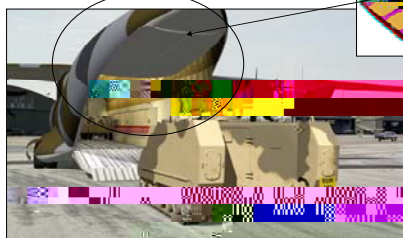

A400M CFC Cargo Door

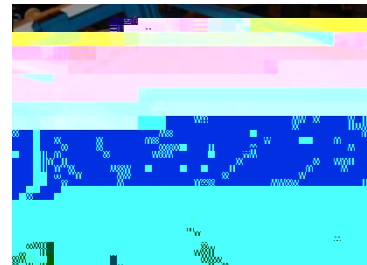

C-17 Main Landing Gear Door



Other BOEING Components

- LAIRCOM panels
- Leading edge 787
- Rear Bulkhead 787

MOTIVATION

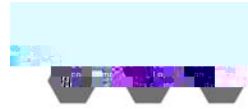

- VARTM process: +/-
 - Main advantages: **low cost, high fiber volume fraction, large scale parts**
 - Still some limitations
 - High variability compared to autoclave process
 - From part to part
 - In the same part
- Following conditions have to be met to make VARTM viable for high-performance aerospace applications:

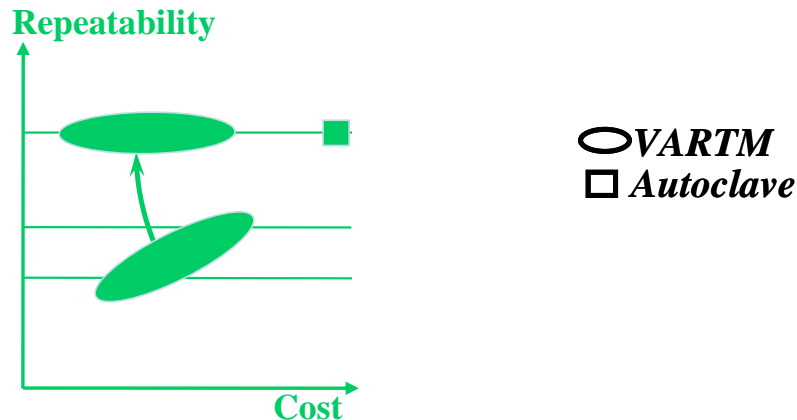

APPROACH

- Three VARTM processes will be evaluated on process repeatability, part quality, and mechanical performance
- Establish the fundamental understanding of the VAP process
- Establish an elevated temperature VARTM workcell for toughened epoxies

VARTM Process Variations

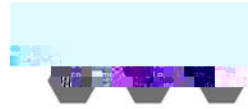
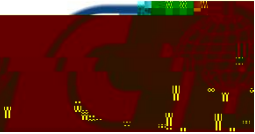

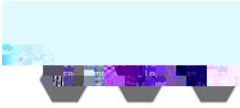

Thickness Behavior Comparison between CAPRI and SCRIMP

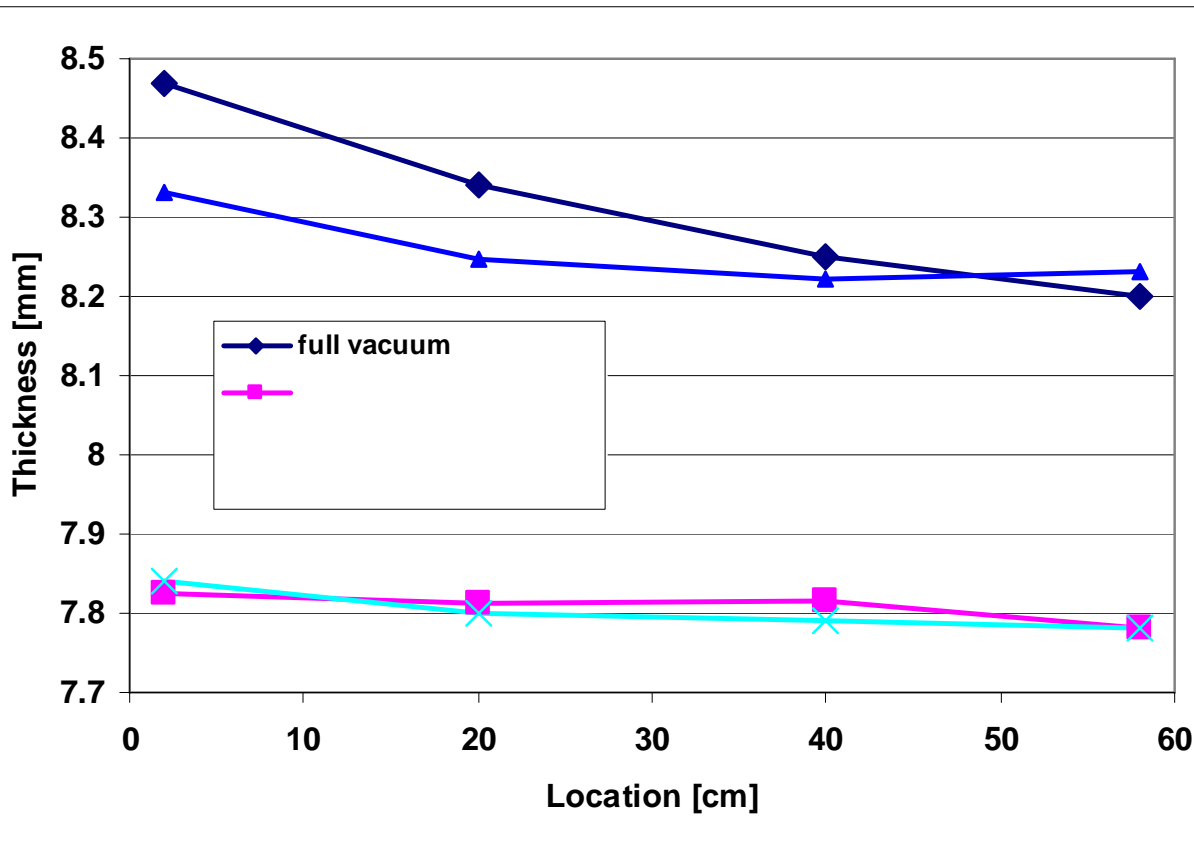

- Debulking can greatly increase final fiber volume fraction
- The thickness gradient is reduced when the CAPRI pressure is applied (insignificant for the debulked case)

MEMBRANE-BASED VARTM PROCESSING (VAP)

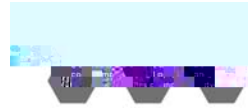

- Utilize membrane cover to allow continuous degassing and uniform vacuum pressure during VARTM processing
 - Reduces void content

Membrane (from W. L. Gore & Associates, GmbH)



- Optical microscope
 - The membrane is mounted on a support
- SEM of the membrane
 - Top surface

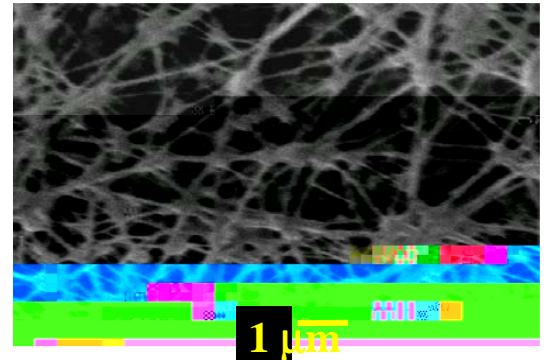
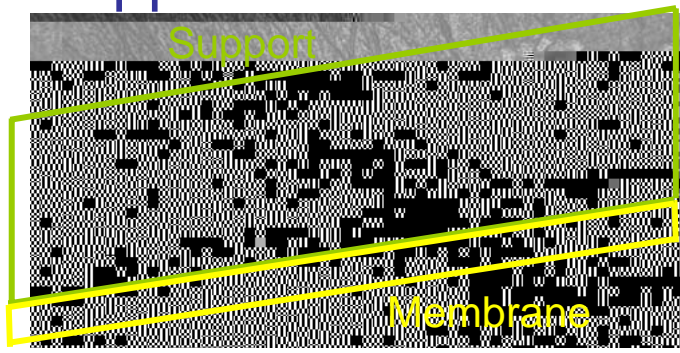

– Cross-section

- SEM of the support

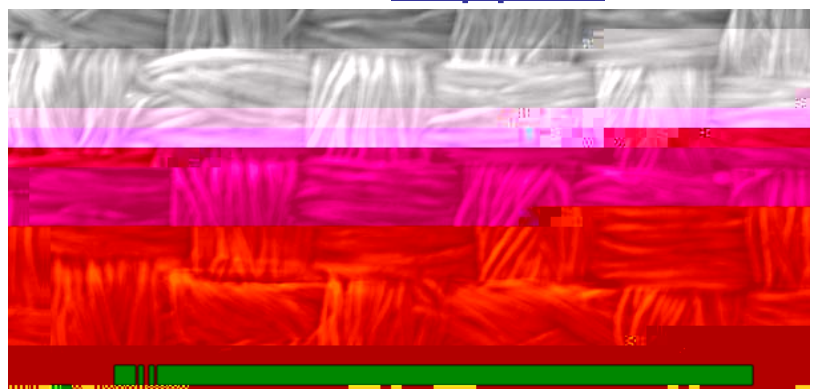



Building blocks the model



- $\dot{\xi}$: Flow front velocity (m/s)
- ξ : Position of the flow front in the pore (m)
- η : Viscosity of the liquid/resin (Pa.s)

Laplace Equation

$$P_c = -\frac{2\gamma \cos \theta}{r}$$

Kozeny-Carman

$$K = \frac{\epsilon^3}{k\tau^2 S^{*2}}$$

$$P_1^* = P_1 + P_c$$

$$\Delta P^* = P_0 - [P_1^* + P_g]$$

$$\dot{\xi} = \frac{K \Delta P^*}{\eta \xi} \quad \text{Darcy's law}$$

$$\int \dot{\xi} dt \Rightarrow \xi = f(t) \text{ or } t = f(\xi)$$

Materials' Characterization



- Membrane's pore size distribution by Porometry
- Fluids' surface tension with the DCA
- Contact angle between fluids and the membrane using a sessile drop method

Fluids	Density (kg/m ³)	Viscosity (cP)	Surface tension (N/m)	Contact angle (°)
HPLC	1000	1	$7.2 \times 10^{-2} \pm 0.7 \times 10^{-4}$	$\theta = 118^\circ \pm 5^\circ$
Vinyl-ester resin system	1024	115 ± 15	$3.3 \times 10^{-2} \pm 0.7 \times 10^{-4}$	$\theta = 83^\circ \pm 8^\circ$
Epoxy resin system	1198	360 ± 7	$3.6 \times 10^{-2} \pm 1 \times 10^{-4}$	$\theta = 98^\circ \pm 7^\circ$

Contact Angle Measurements

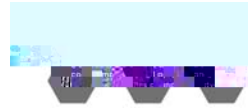
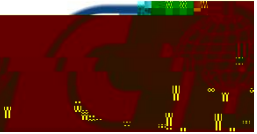

Capillary Porometry

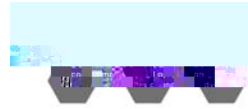
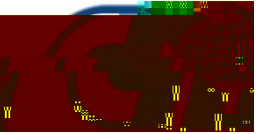

General characteristics



	Material of the membrane	Thickness	Bubble point		Mean Flow Pore	
		μm	Pore size (diam) (nm)		Pore size (diam) (nm)	
		Approximation	average	std dev	average	std dev
W1	ePTFE	50	247	6	130	6
WA	ePTFE	75	606	10	255	3
WB	ePTFE	30	469	4	221	6
WC	ePTFE	7	337	13	188	8
D6501	ePTFE	230	351	15	150	1.1
D6504	ePTFE	200	219	13	101	2.4
D1302	ePTFE	250?	566	19	256	10



Support of the Donaldson membrane

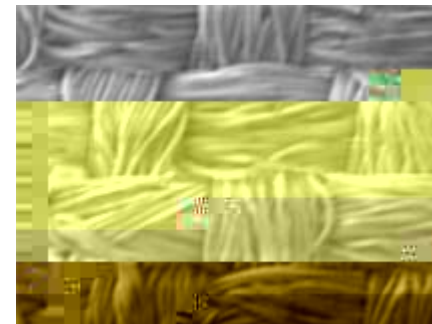

Support of the membrane by W. L. Gore and Associates

- Three membranes from Gore
- Two membranes from Donaldson

Pore size distribution

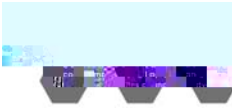

- The pore size distributions of the different membranes seem to match a 3-parameters lognormal fit; this finding will be used at the end of the project to provide membrane's users with guidelines, which correlate porometry data with membrane performance
- Examples with D1302 and WA

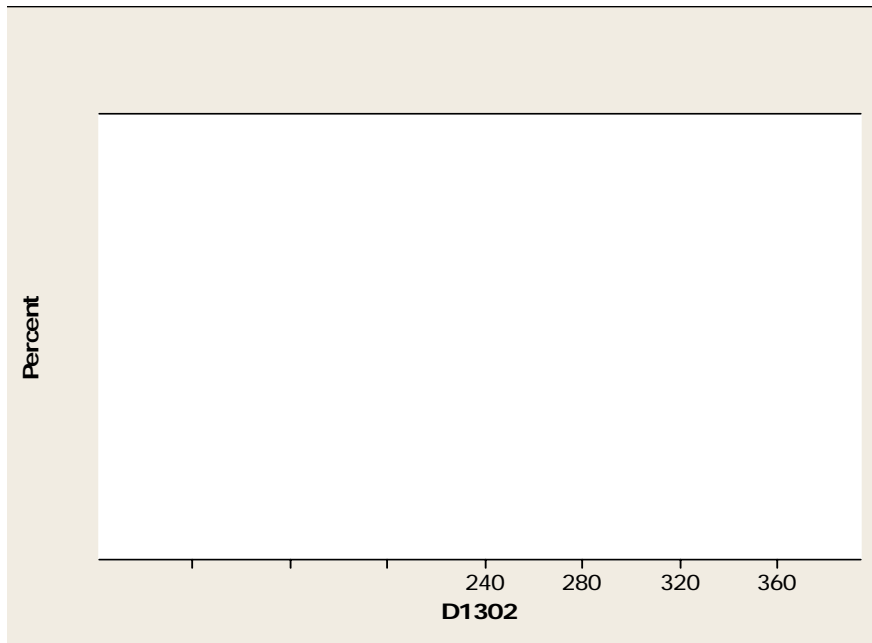

Membrane Flow and Permeability Simulation



Porometry data

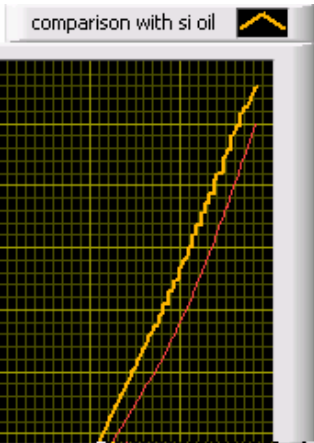
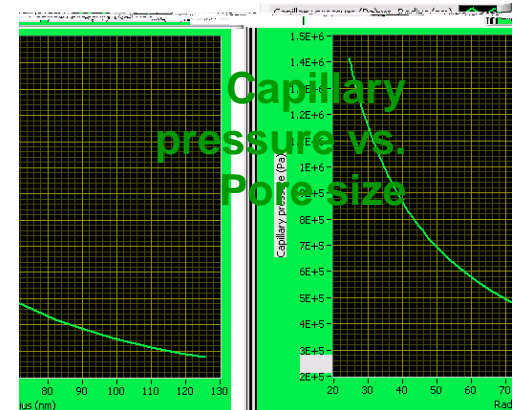
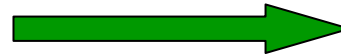
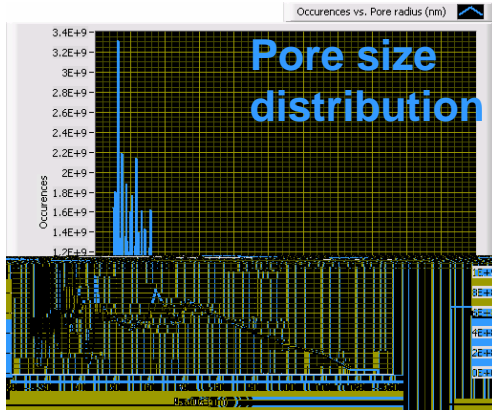

- (1) Number of pores of each size
- (2) Hagen Poiseuille in all pores
- (3) Correction factor for air flow
- (4) Calculation of flow with fluid of interest and correction factor
- (5) Calculation of permeability using Darcy's law

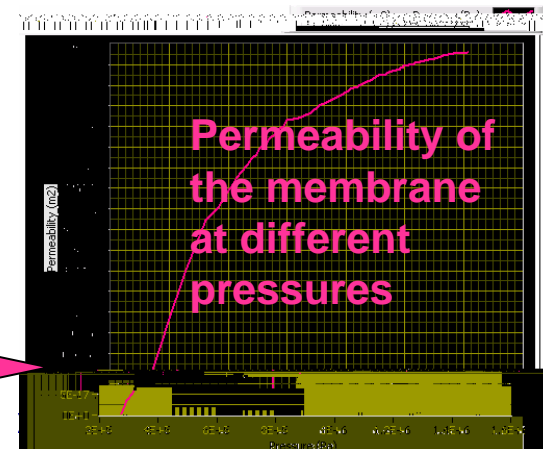

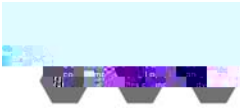

Autoclave experiments

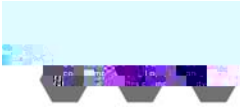

Motivation

Prove that the impregnation is driven by the capillary pressure of the largest pore.

Principle

Model:

ΔP is the pressure applied during the process (vacuum for VARTM)

From the model:

Considering a non-wetting resin ($P_{\text{capillary}} < 0$)

If ΔP

Autoclave Setup

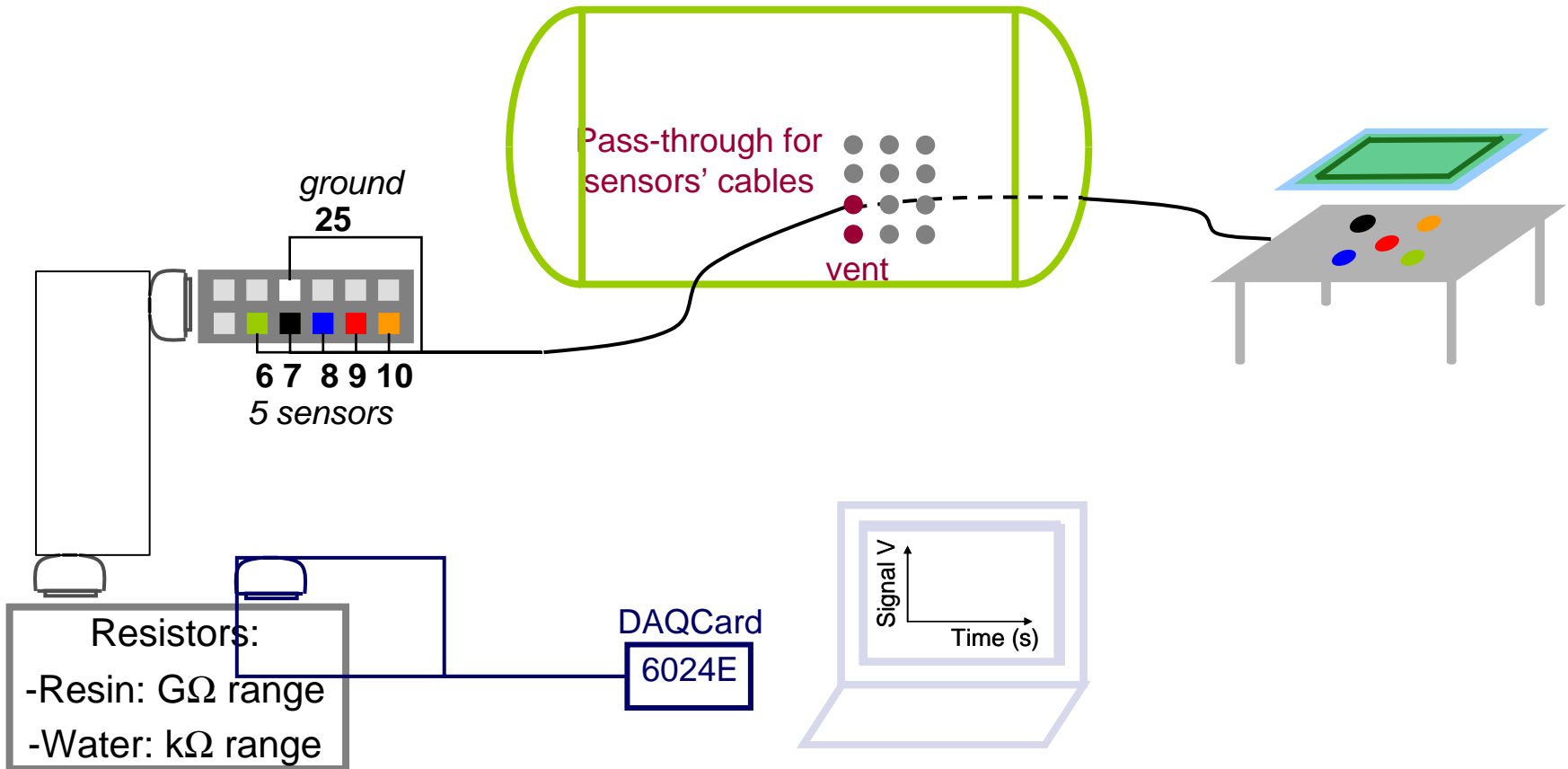

Autoclave: HPLC

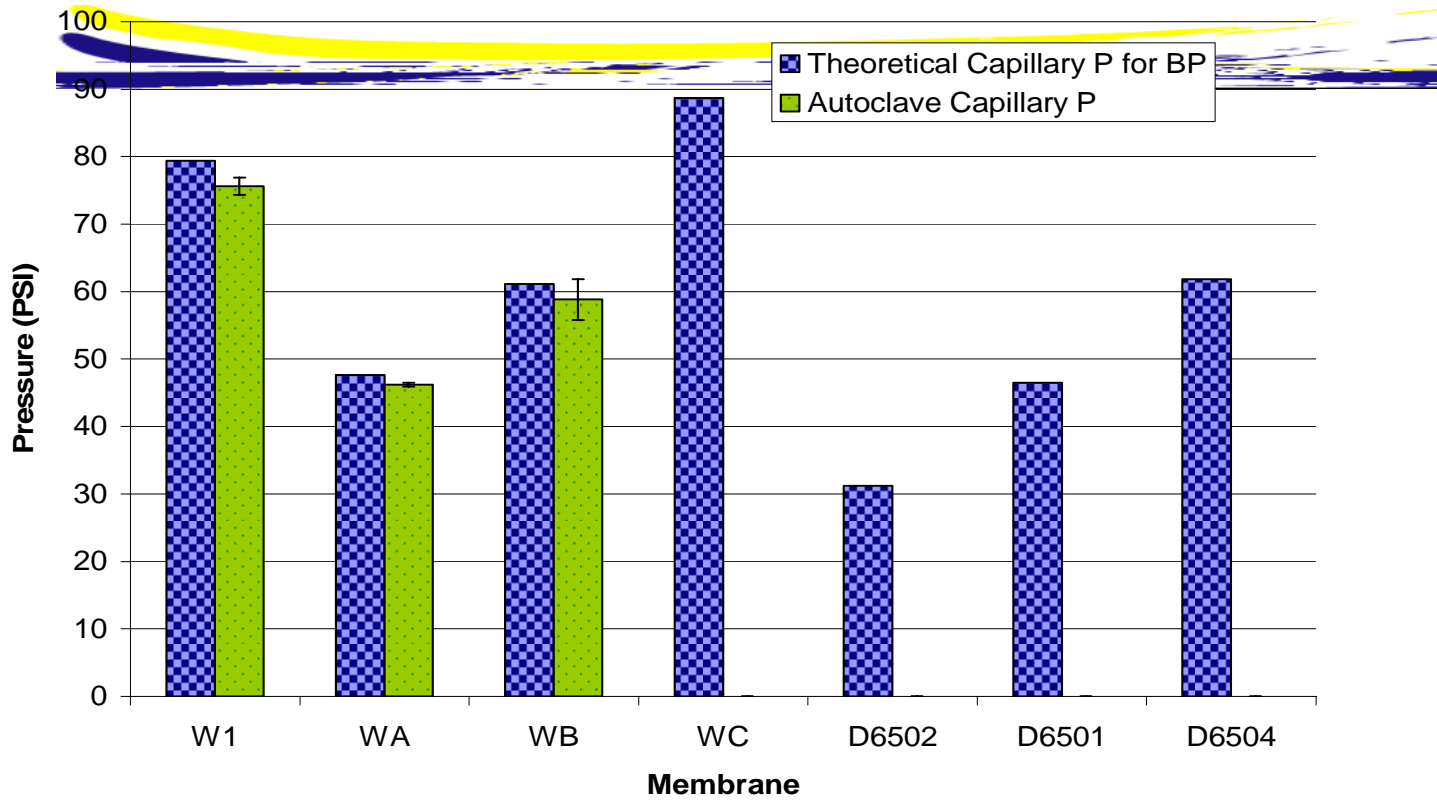

Good correlation between the theoretical capillary pressure measured for the bubble point and the experimental results.

Ongoing work includes the experimental evaluation of the capillary pressure of the membranes WC, D6501, D6502 and D6504.

Autoclave: SC15

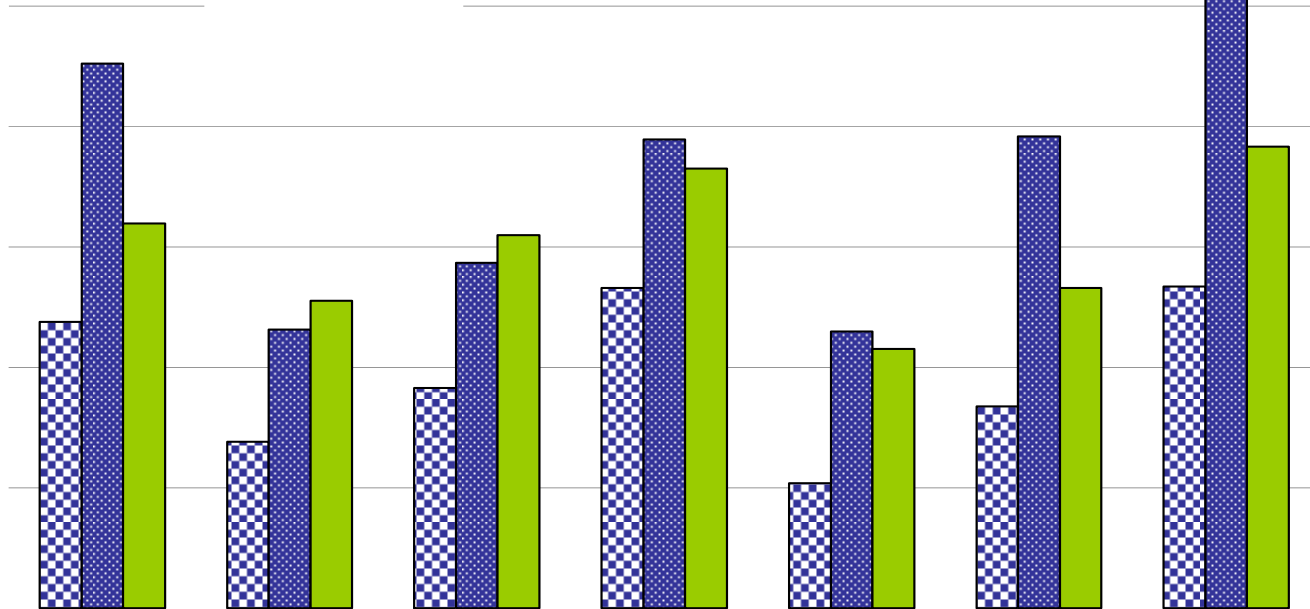
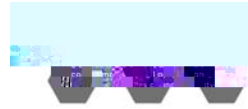
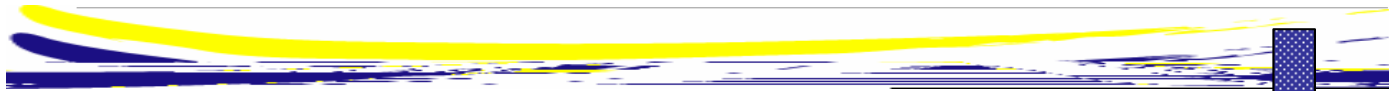

On-Going Work Draping Investigations

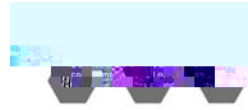
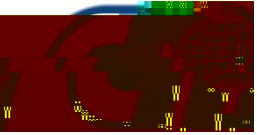
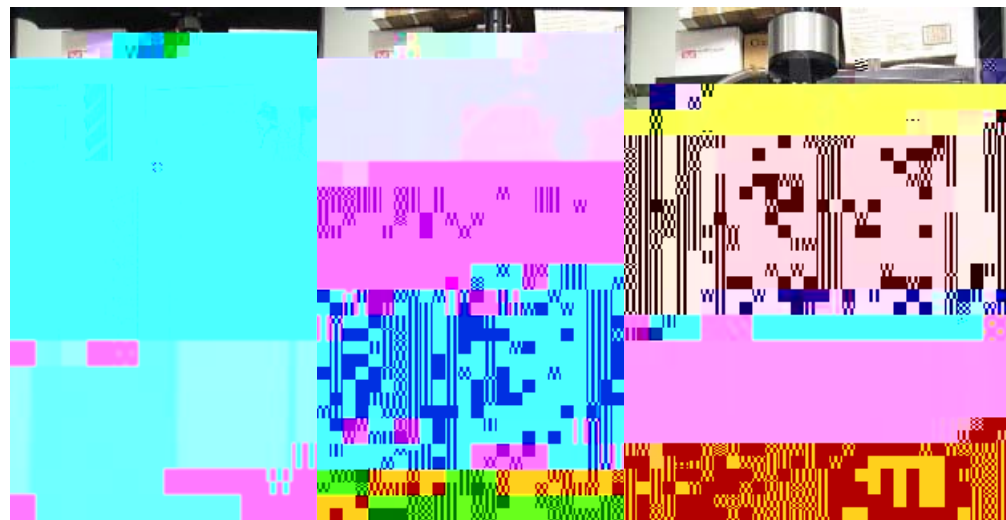
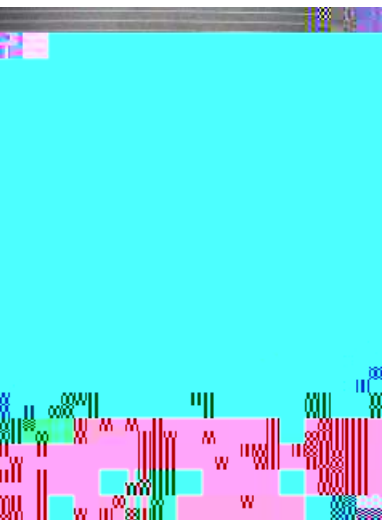
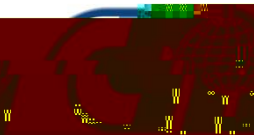

Illustration of the membrane stretching





Conclusions and Future Work



- A model was introduced to predict the impregnation time of the membrane by different resins
 - There is a good match between experiments and theory, given that the input parameters present variations
- An experimental procedure was developed to investigate the driving force responsible for the success/breakdown of the membrane using the autoclave
 - The tests with water seem to be convincing, although it is not the case for the epoxy SC15
- Mechanical testing of the membrane was conducted to address the deformation encountered by the membrane while being used during manufacturing
 - Basic characterization and a strain rate dependency study give the basis of this study
 - A unique setup was built to promote biaxial stretching and evaluate its impact on membrane's performances

Aerospace VARTM Requires Elevated Temperature Processing

- Ø Sensor Based Infusion Technology
- Ø Robust System Construction
- Ø Re-Configurable Infusion Schemes
- Ø Improved Resin Mixing System
- Ø Statistical Data Sampling During Infu



**TRANSITIONED FOR R&D
AND PRODUCTION AT
DASAULT AVIATION (Paris,
France)**

CONSIDER TWO AEROSPACE TOUGHENED EPOXY SYSTEMS

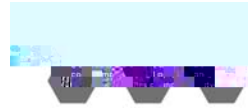

- **Cytec Epoxy Cycom 977-20**
 - Viscosity = 120 cps @ 167°F
 - Ramp with 4°F/min to 355 cure for 3 hours, cool to 140°F @ 5°F/min
 - Cured Resin Density = 1.31g/cm²
 - Tg = 212°C
- **Hexcel Epoxy RTM 6**
 - Viscosity = 180 cps @ 177°F / 40 cps @ 248°F
 - Ramp with 5°F/min to 320 °F, cure for 75 minutes
 - Cured Density = 1.14g/cm²
 - Tg = 183°C (Hexcel Datasheet)



Develop Property Database



1. Unnotched Tensile D-5766
2. Unnotched Compression D6484
3. Open hole compression D-6484
4. Filled Hole Compression D-6742-02
5. Pin Bearing D-5961
6. Short Beam Shear D-2344
7. Drop weight Impact D 7136
8. Compression after Impact (CAI) D-7137
9. Interlaminar Tension (D-5415)

**ALL Tests will be conducted at room temperature
and 180F/80% hot/wet conditions**

NAVAIR P3-Orion Replacement Project

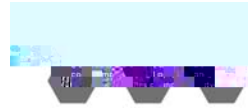

- Leverage FAA and ONR funded design, process, materials, and prototyping technologies to develop flight worthy replacement article(s) for the P3 surveillance aircraft.
 - Exploit / Develop Composite Design & Analysis Capabilities
 - Develop Elevated Temperature VARTM (ETV) Process
 - Produce test article for flight testing of trailing edge panel
 - Lay groundwork for certification of composite part for P3 replacement
- Develop a model

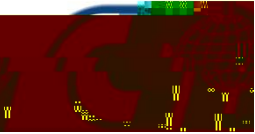

A Look Forward

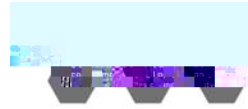

- Benefit to Aviation
 - Improved fundamental understanding of VARTM processing to understand benefits and disadvantages of various process variations
 - Reduce part-to-part variations / improve allowables
 - Automated VARTM will allow QA/QC of part production reducing costs and improve quality while maintaining traceability
 - Open-access database of structural properties
- Future needs
 - Work close with VARTM manufacturers to transition technology
 - Improve VARTM to achieve autoclave-level fiber volume fraction
 - Investigate more complex geometries / unitized structures

Pin Bearing Test ASTM D 5961



Sample Numbered and Drilled

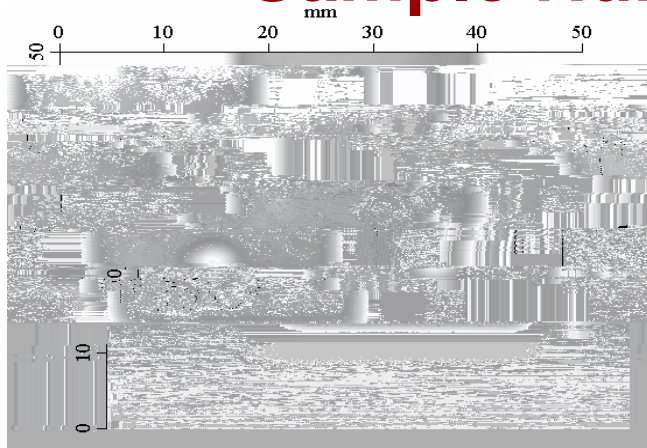

C-scan of hole to identify drilling damage or local impurities.

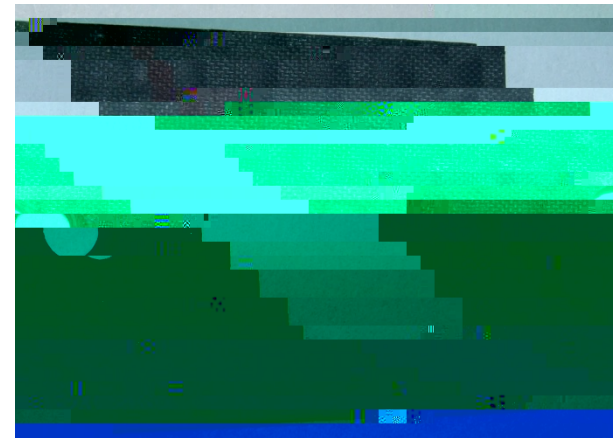

Post testing hole damage.

P3 Trailing Edge Flap



- 802753 Trailing Edge Panel

-

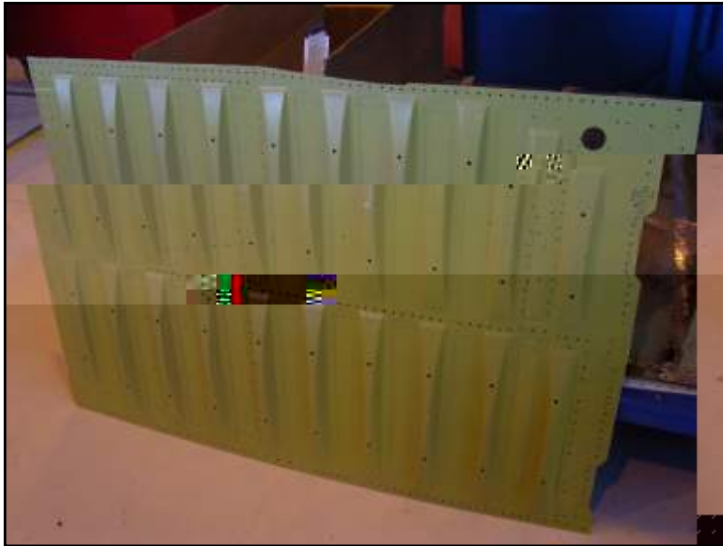

Bearing Test Results

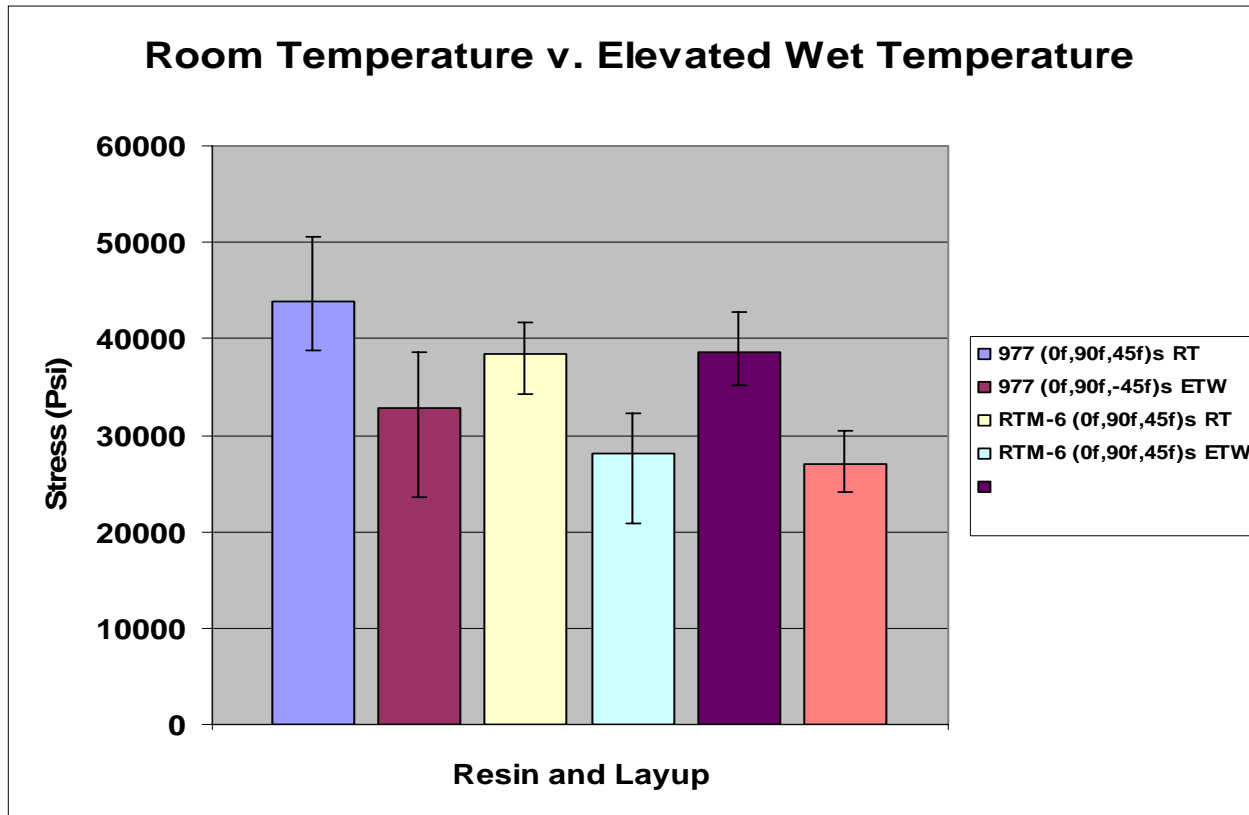

- Typical reduction for elevated temperature wet conditions (180F, 80% wet) are observed
- Cycom 977-20 pin bearing strength is slightly better than RTM6 system

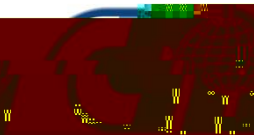

The Joint Advanced Materials and Structures Center of Excellence

